

# DI-917MB/DI-918MB

## Multi-Channel Analog Output Modules

DC Current or  
DC Voltage Outputs  
Discrete Outputs

### Models

DI-917MB: 4 current output channels  
DI-918MB: 4 voltage output channels

### Analog Output

DI-917MB: 0 to 20mA, 4 to 20mA, 0 to 1mA DC

DI-918MB: 0 to 10V, 0 to 5V, 0 to 1V DC

### Discrete Output

Four output channels:  
Open-drain MOSFETs (1A DC loads)  
0 to 35V DC

### Network Communication

Modbus-RTU high-speed RS-485

### Power Requirement

10 to 36V DC, 24V AC

### Approvals

CE marked. UL, cUL listed  
Class I; Division 2; Groups A, B, C, D.

These modules drive four analog output channels and also feature four discrete outputs for on/off control. Isolation separates the output, power, and network circuits. Network communication adheres to the industry-standard RS-485 Modbus RTU protocol. AC and DC power sources are supported with nonpolarized, diode-coupled terminals.

The analog outputs generate a signal based on communication from the host. They accommodate wide DC voltage or current ranges.

Discrete outputs provide simple on/off switching capability (open-drain) for external devices.

Combining analog outputs, on/off controllers, and a network interface in a single package, makes this instrument extremely powerful. Multi-channel design adds cost-efficiency and allows high-density mounting. Plus, safe, rugged construction make it reliable for both control room and distributed field I/O use in a broad range of temperature control applications. Custom module configurations are also possible (consult factory for details).



## Features

- Standard Modbus RTU protocol with high-speed RS-485 communication (up to 115K bps)
- 12-bit D/A yields 0.1% of span resolution and accuracy
- Four analog outputs in an inch-wide module reduces system costs and saves panel space
- Four discrete outputs enable host-controlled on/off switching
- Heavy-duty 1A solid-state relays provide dependable on/off control of industrial devices
- Self-calibration lowers maintenance costs by reducing periodic manual calibration checks
- Watchdog timers provide a configurable failsafe output state for use when host I/O communication is lost
- Three-way isolation eliminates potential ground loops between power, output, and network circuitry
- Self-diagnostics monitor microcontroller activity to detect operational failures (lock-up) and execute a reset to restore communication

## Analog Output Module

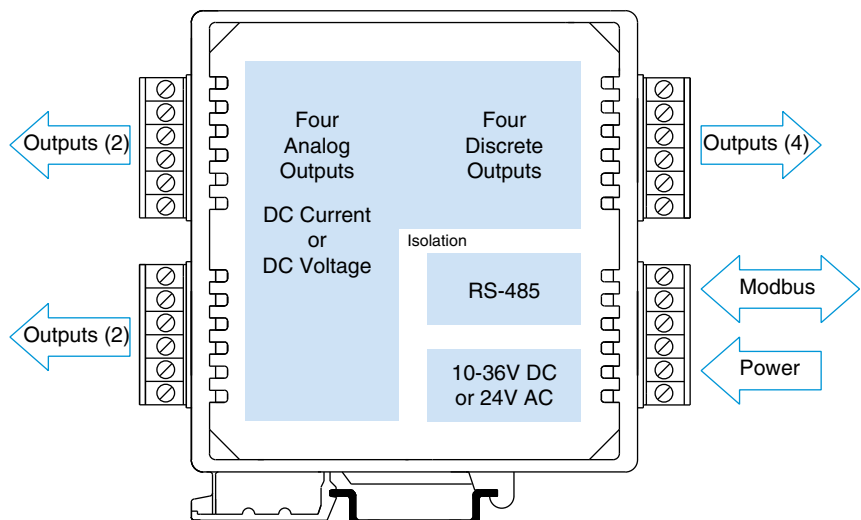

# Performance

## General Analog Output Resolution

See current/voltage output specifications for more information.

## Ambient Temperature Effect

Better than  $\pm 0.001\%$  of output span per  $^{\circ}\text{C}$ , or  $\pm 1.0\mu\text{V}/^{\circ}\text{C}$ , whichever is greater.

## Ambient Temperature

Operation (917MB):  
 $-25^{\circ}\text{C}$  to  $60^{\circ}\text{C}$ \* ( $-13^{\circ}\text{F}$  to  $140^{\circ}\text{F}$ ).

Operation (918MB):  
 $-25^{\circ}\text{C}$  to  $70^{\circ}\text{C}$  ( $-13^{\circ}\text{F}$  to  $158^{\circ}\text{F}$ ).

Storage:

$-40^{\circ}\text{C}$  to  $+85^{\circ}\text{C}$  ( $-40^{\circ}\text{F}$  to  $+185^{\circ}\text{F}$ ).

\* Limit 917MB maximum ambient to  $50^{\circ}\text{C}$  ( $122^{\circ}\text{F}$ ) when using supply voltages less than 15V DC.

## Current Output (DI-917MB)

### DC Current Output Ranges

Range user-configured. Range selected applies to all channels.

Output Range	Resolution	Accuracy (% span)
0 to 1mA	0.554%	$\pm 2.0\%$ ( $\pm 0.002\text{mA}$ )
0 to 20mA	0.028%	$\pm 0.1\%$ ( $\pm 0.02\text{mA}$ )
4 to 20mA	0.035%	$\pm 0.1\%$ ( $\pm 0.02\text{mA}$ )

### Maximum Output Current

22.5mA DC typical.

### Integral Non-Linearity

$\pm 0.1\%$  of span or  $\pm 2$  LSB typical, whichever is larger, for spans equal to or greater than 16mA.

### Output Compliance

12V minimum, 12.7V typical.

### Output Load Resistance Range

0 to 630 ohms typical.

### Response Time

11ms typical into 500 ohms, for measurement to reach 98% of the final value in response to a step command. Actual response time will vary with load.

## Voltage Output (DI-918MB)

### DC Voltage Output Ranges

Range user-configured. Selection applies to all channels.

Output Range	Resolution	Accuracy (% span)
0 to 1V	0.274%	$\pm 0.6\%$ ( $\pm 6\text{mV}$ )
0 to 5V	0.055%	$\pm 0.1\%$ ( $\pm 5\text{mV}$ )
0 to 10V	0.027%	$\pm 0.1\%$ ( $\pm 10\text{mV}$ )

### Maximum Output Voltage

11.25V DC typical.

### Integral Non-Linearity

$\pm 0.1\%$  of span or  $\pm 2$  LSB typical, whichever is larger, for spans equal to or greater than 5V.

### Output Current

0 to 10mA DC maximum.

### Output Impedance

1 ohm.

### Output Short Circuit Protection

Included.

### Response Time

110 $\mu\text{s}$  rise time typical, 150 $\mu\text{s}$  fall time typical, unloaded, for output to reach 98% of the final value in response to a step command. Time varies with load.

## Discrete Output

### Output Type

Four independent open drain MOSFET switches with a common return that operate as low-side switches.

### Output Voltage Range

0 to 35V DC (up to 1A/channel continuous). External voltage source required.

### Output ON Resistance

0.15 ohms maximum.

## Operation

Digital outputs are set to their OFF state following a software or power-on reset. Outputs may be set to user-defined states following a watchdog timeout. Watchdog timeout output control takes precedence over limit alarm control. Alarm control takes precedence over host control.

### Output Response Time

4.1ms typical, from receipt of command to gate transition of the output MOSFET.

## Communication

### Supported Modbus Commands

The command/response protocol for communicating with this module adheres to the Modbus/RTU standard for the following Modbus Functions.

- Read Coil (Output) Status
- Read Holding Registers
- Read Input Registers
- Force Single Coil (Output)
- Preset Single Register
- Force Multiple Coils (Output)
- Preset Multiple Registers
- Report Slave ID
- Reset Slave

### LED Indicators

LEDs indicate power, status, and discrete level/alarm.

## Power and Isolation

### Power Requirements

10 to 36V DC (DI-918MB), 12 to 36V DC (DI-917MB) 22 to 26V AC.

### Supply Current

Supply	Current Draw (917)	Current Draw (918)
10V DC	Not Recommended	100mA max
12V DC	275mA maximum	85mA max
24V DC	120mA maximum	45mA max
24V AC	210mA rms max.	85mA rms max

### Isolation

1500V AC for 60 seconds or 250V AC continuous. 3-way isolation between outputs, network, and power circuits.

## ANALOG OUTPUT CONNECTIONS

### DC CURRENT OUTPUT

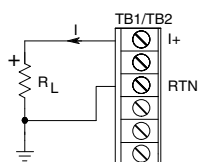

### DC VOLTAGE OUTPUT

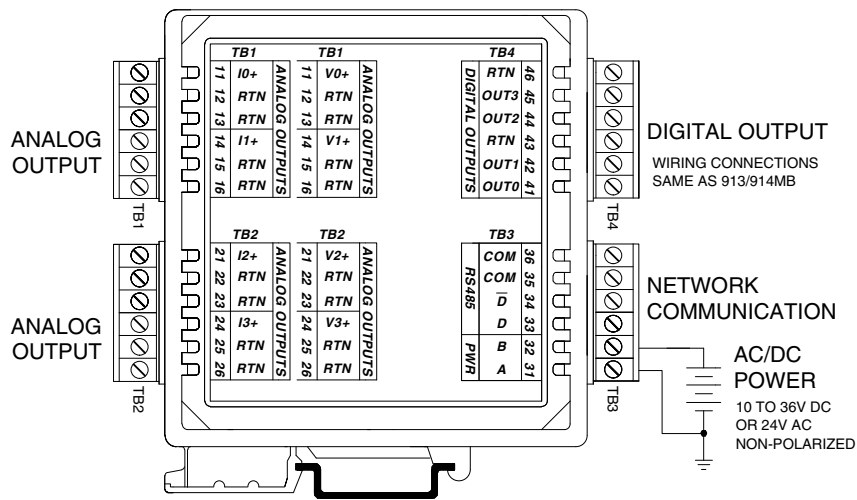
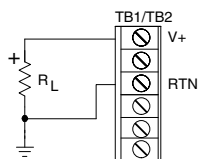

# 900MB Technical Diagram

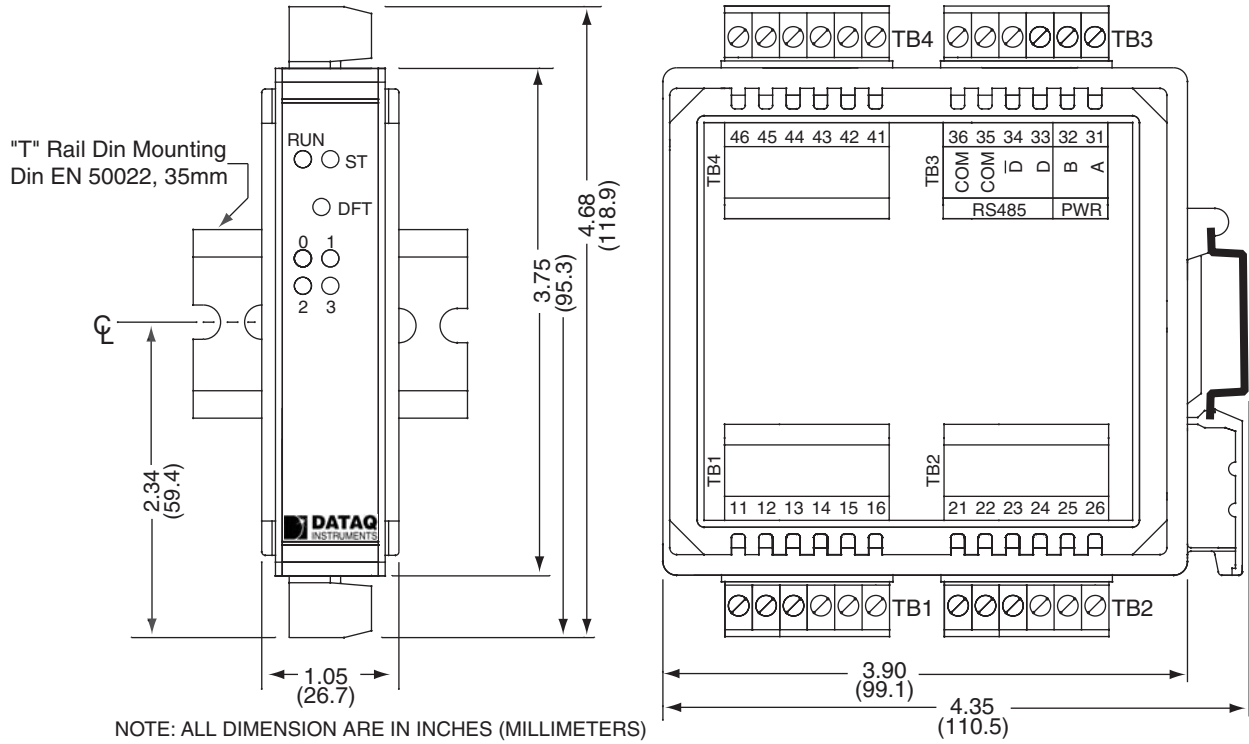

## Communication Connections

Personal Computer with  
Windows 95, 98, ME, NT, 2000, XP

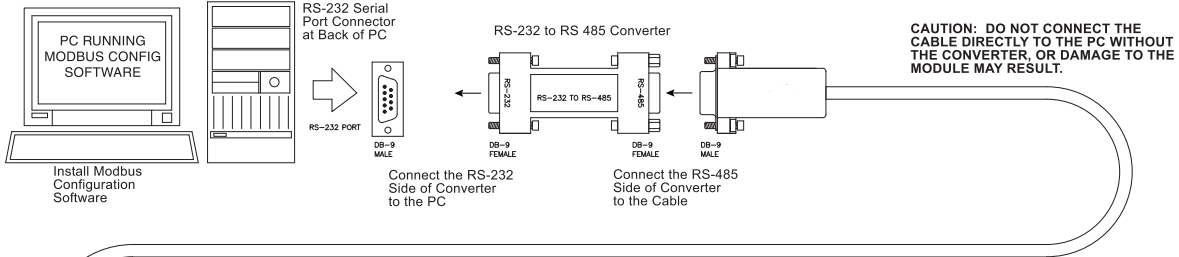

## 100969 COMMUNICATION CONNECTIONS

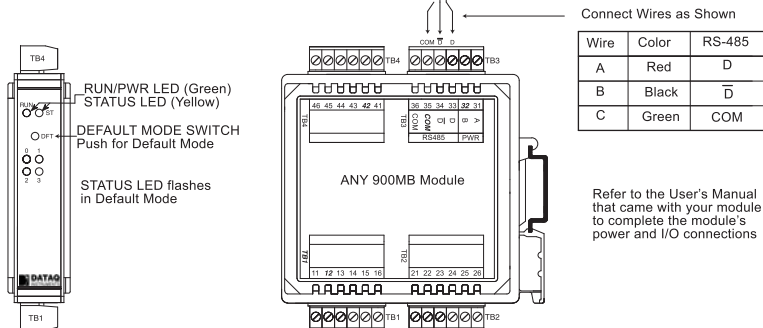

## Software Interface Package

DATAQ Instruments, Inc., provides a full set of tools to help you get your modules set up and ready to run in an easy-to-order package that includes the Windows Configuration Software, an RS-232 to RS-485 Serial Port Converter, and an RS-485 Signal Cable.

The Software Interface Package Includes the following:

- Configuration Software for Windows (95, 98, ME, NT, 2000, XP) on CD-ROM.
- Non-isolated RS-232 to RS-485 Serial Port Converter, DB-9S to DB-9F.
- RS-485 to 3-wire Cable Converter, DB-9M to 3 x 12 AWG RS-485 Cable, 8 ft.

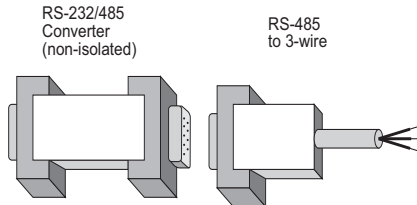
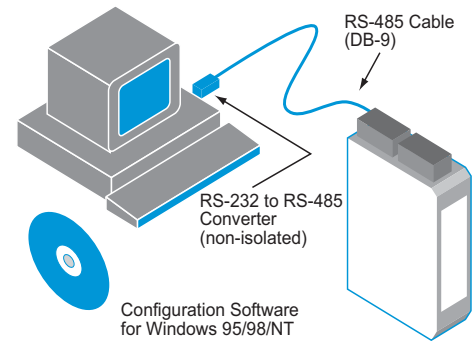

### RS-232 to RS-485 Serial Port Converter

This Serial Port Converter is a non-isolated, port-powered, RS232-to-RS485 signal converter. Although the converter receives its power from the RS232 data and handshake lines, no handshaking lines are required to control the converter's RS485 driver. It plugs directly into the DB-9 male RS232 serial port connector on the back of most personal computers via the cable provided in the interface package.

Model Number  
100969

### Windows Configuration Software

The Windows Configuration Software provides an easy way to configure your module to whatever your application may be. The configuration software provides the following capabilities:

- Change Host and Slave communication settings (Baud Rate, COM Port, address, et al.
- Monitor the discrete I/O signal states and watchdog status allowing discrete outputs to be turned on/off.
- Allows a configuration to be uploaded or downloaded to/from the module via the RS 485 interface.
- Provides controls to reset the module.
- Reads the contents of the Module Status Register.
- Allows optional user documentation to be saved with a module file.
- Allows a module's complete configuration to be printed in an easy-to-read, single-page format, including user documentation.

Test page (right) simplifies diagnostics with a live visual display of the module's input and output values.

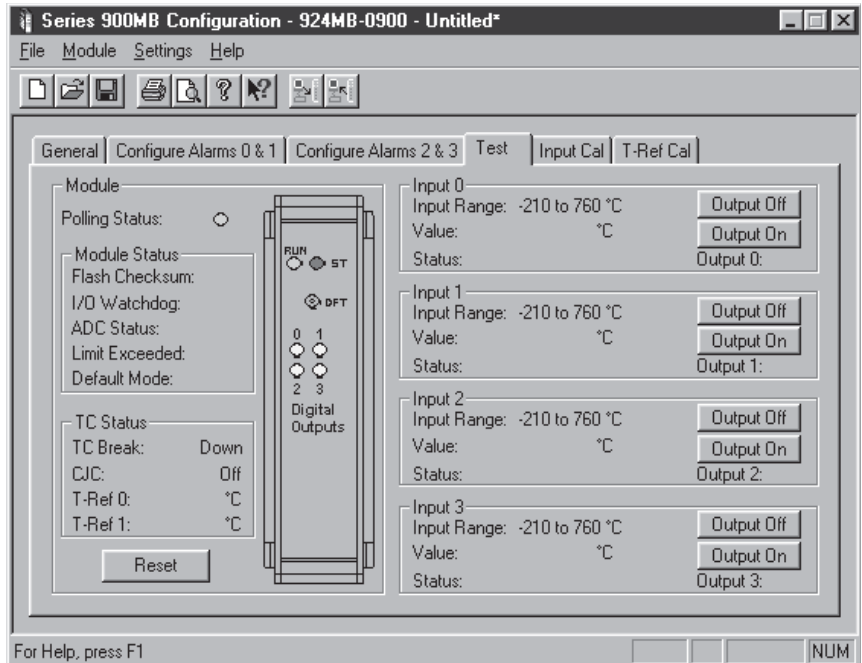

## Software Support

DI-900MB series products are designed for Modbus RTU compatibility. Modbus is a communication protocol developed by MODICON, Inc. in 1979. In the years since its release, Modbus has evolved into a truly open standard and has become the most widely used networking communication protocol in the industrial automation field. Virtually all SCADA and HMI application software packages can easily fold DI-900MB devices into any new or existing data acquisition and control environment. DI-900MB products support the RTU (Remote Terminal Unit) Modbus extension, which is a binary protocol providing enhanced performance. The following is a brief list of Human Machine Interface (HMI) software vendors who support the Modbus RTU protocol, and therefore support DI-900MB Series products. The space available does not allow an exhaustive list.

### Citect

USA Tel # (704)-329-3838  
Web: <http://www.citect.com/>  
Modbus-RTU I/O support: DLL Driver - use Modicon PLC 484 Series; OPC Server supplied by others

### Intellution/GE Fanuc

USA Tel. (508) 698-3322  
Web: <http://www.intellution.com/>  
Modbus-RTU I/O support:  
OPC Server – supplied by Intellution

### Wonderware

USA Tel. 949-727-3200  
Web: <http://www.wonderware.com/>  
Modbus-RTU I/O support: Driver – Fast DDE; OPC Server – supplied by others

### Iconics

USA Tel. (508) 543-8600  
Web: <http://www.iconics.com/>  
Modbus-RTU I/O support: Driver – supplied by Iconics; OPC Server – supplied by others

### OPC Servers Vendors

#### KEPware, Inc.

USA Tel. 207-864-5881  
Web: <http://www.kepware.com/>

#### Digital Systems, Inc.

USA Tel. 704-895-7713  
Web: <http://www.caro.net/dsi/>

#### Automated Solutions, Inc.

USA Tel. 707-575-9631  
Web: <http://www.automatedsolutions.com/>

# Isolated Signal Converter

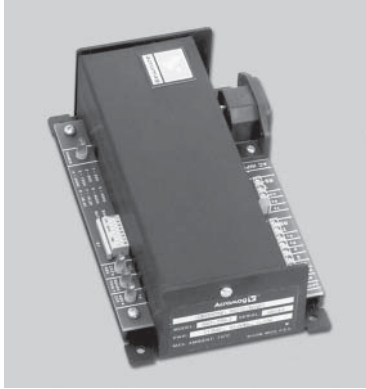

This unit provides an isolated interface between the host PC's RS-232 port and RS-485 Modbus network devices. Signal conversion is bidirectional with operation that is transparent to all devices. The RS-485 network supports up to 32 devices (including the converter) across 4000 foot distances. Installation of additional network devices or extending the distance requires an Isolated Network Repeater (Model Numbers 100977 or 100978). Power cord included. Signal Cable (Model 100976) connects the PC's RS-232 Port to the Isolated Signal Converter.

## Specifications

### Baud Rates

Switch-selectable from 300 to 38.4K baud.

### Duplex

Half duplex only.

### Network Termination Resistors

Two terminal blocks and 120 ohm resistors provided to terminate both ends of the RS-485 network.

### Wiring Connectors

Terminal blocks with screw clamps for 14-26AWG

### Operating Temperature Range

-25 to 60°C (-13 to 140°F)

### Isolation

Withstands 1500V AC surge for 60 seconds (250V AC or 354V DC continuous).

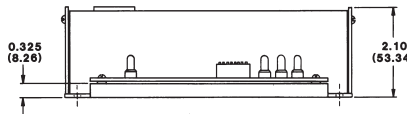
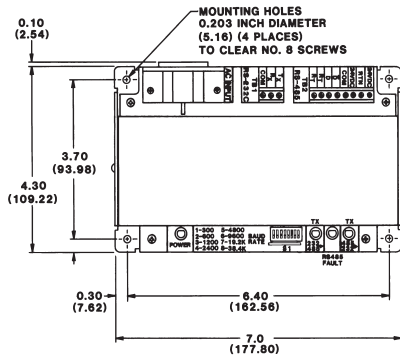

### Model Numbers

100974 (115V AC Power) (discontinued)  
 100975 (230V AC Power) (discontinued)  
 100976 (8ft. long DB-9 to 3-wire RS-232 Cable)

## System Connection

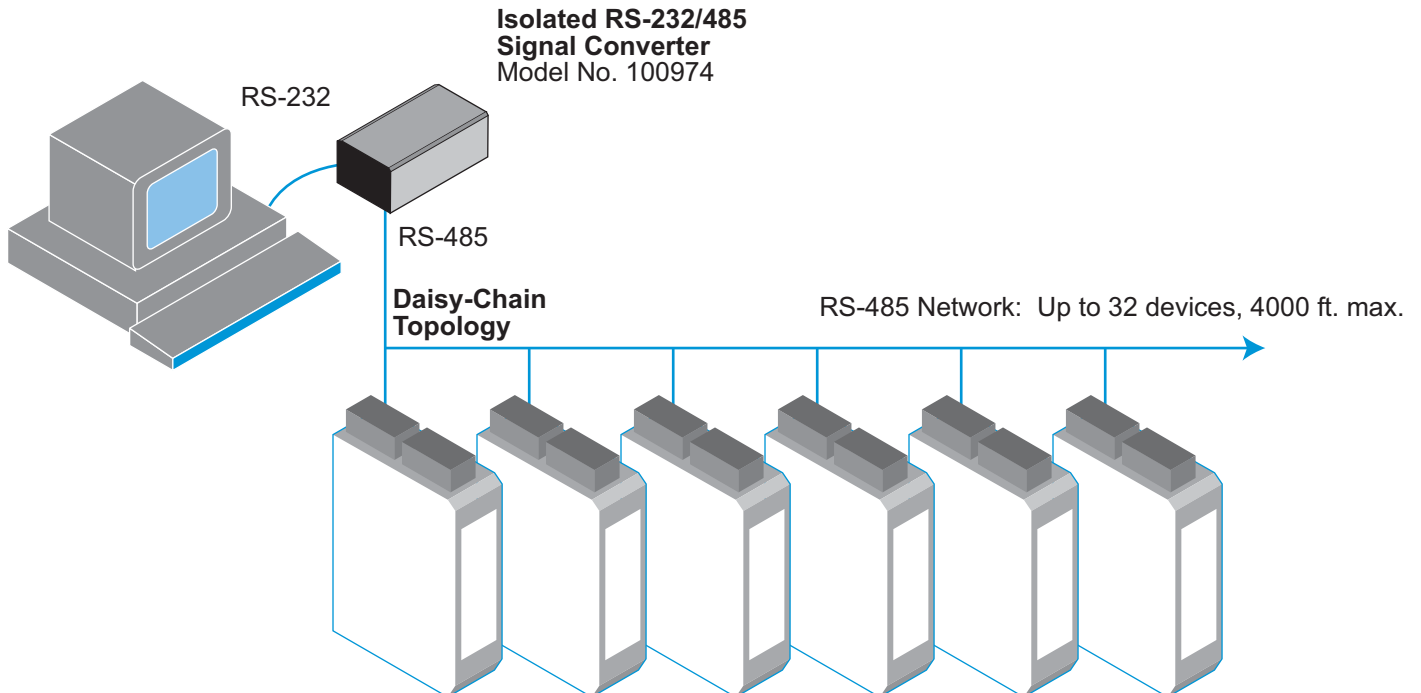

# Isolated Network Repeater

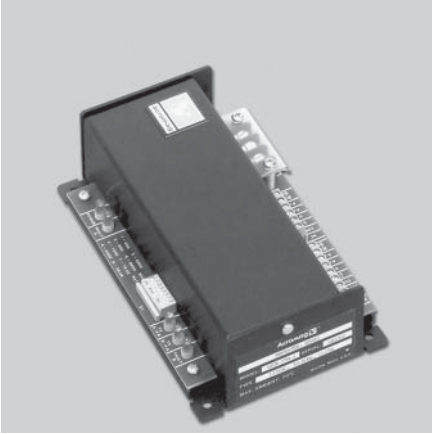

This unit isolates and boosts RS-485 signals to extend communication distances or increase the number of devices on the network. Each Repeater permits the addition of a network branch with up to 32 devices (including the Network Repeater) and will transmit RS-485 signals another 4000 feet. Operation is transparent to all devices and no handshaking is required. Two terminal blocks are provided for 120 ohm resistors to terminate both ends of the network branch.

## Specifications

### Baud Rates

Switch-selectable from 300 to 38.4K baud.

### Duplex

Half duplex only.

### Network Termination Resistors

Two terminal blocks and 120 ohm resistors provided to terminate both ends of the RS-485 network.

### RS-485 Wiring Connectors

Terminal blocks with screw clamps for 14-26AWG.

### Power Wiring Connections

Terminal block with screw clamps for 12-18AWG.

### Operating Temperature Range

-25 to 60°C (-13 to 140°F).

### Isolation

Withstands 1500V AC surge for 60 seconds (250V AC or 354V DC continuous).

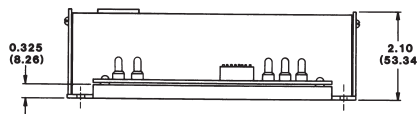
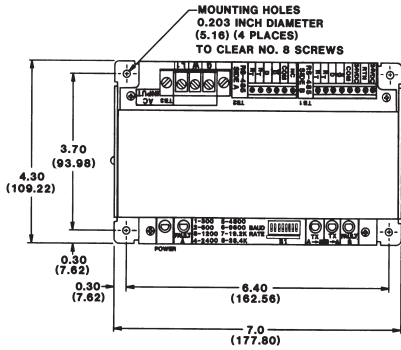

### Model Numbers

- 100977 (115V AC Power)
- 100978 (230V AC Power)
- 100979 (115V AC Power Cord)

## Extending the Network

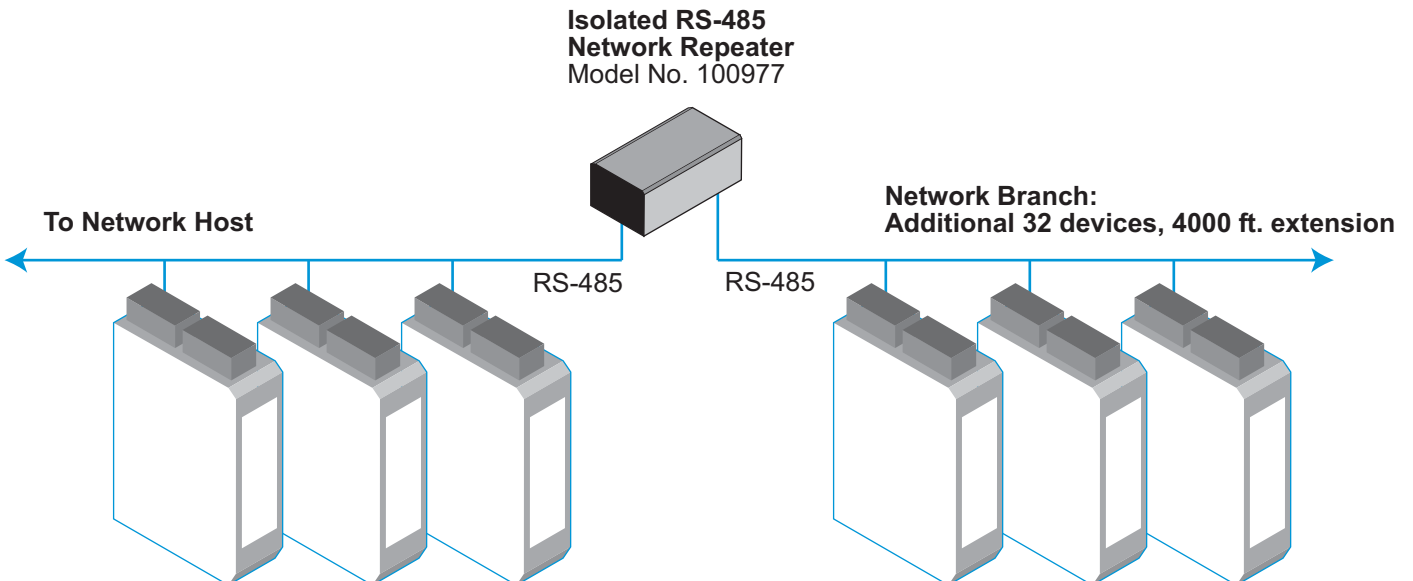

## Universal 50W Power Supply

This Universal 50W Power Supply is the ideal power source to drive your network.



**Input Power Requirement**  
 Universal power  
 85 to 264V AC,  
 105 to 370V DC

**Output**  
 24V DC, 2.1A (50W)

### Top View

(dimensions in mm)

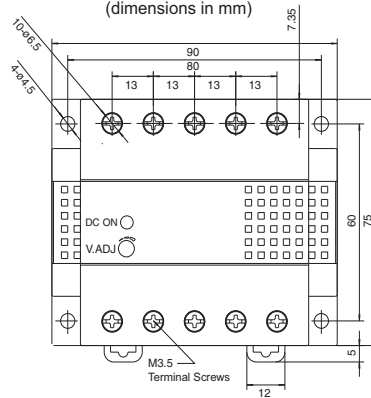

### Side View

(dimensions in mm)

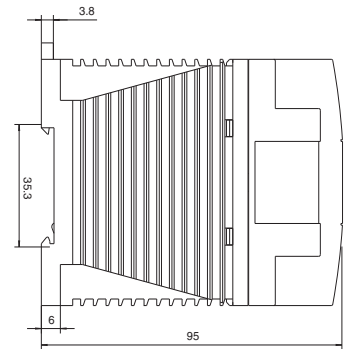

**Model Number**

100980

## DIN-Rail Mounting

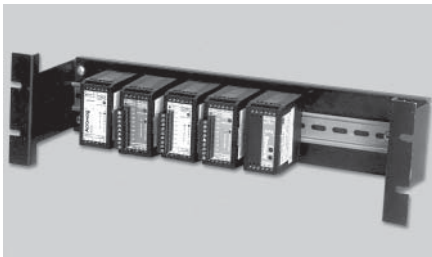

For your convenience, DATAQ Instruments, Inc., offers a rack mount kit to simplify your system installation. This 19-inch kit provides a clean solution for mounting your I/O modules and a power supply. Holds up to 16 DI-900MB modules.

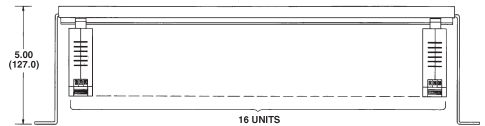
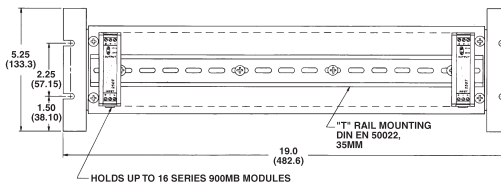

**Model Number**

100971

## USB to RS-232 Adapter



Convert signals from RS-232 to USB with this convenient adapter. For use with all DI-900MB Series modules.

### Dimensions

Length: 3.15 in (8.0 cm)  
 Height: 0.80 in (2.03 cm)  
 Width: 1.75 in (4.44 cm)  
 Weight: 1.6 oz (45.36 g)

**Model Number**

100970

## General Module Specifications

### Communication Interface

#### Network Communication

Modbus-RTU protocol, RS485 (3-Wire). Standard Protocol implementation as defined under "Modicon Modbus Reference Guide" PI-MBUS-300 Rev. J. Reference: <http://public.modicon.com>. Search on: PI-MBUS-300 for technical publication.

#### Baud Rate

2400, 4800, 9600, 14.4k, 19.2k, 28.8k, 38.4k, 57.6k, 76.8k, or 115.2k baud. Default 9600 baud.

#### Module Addressing

0 to 247, selectable. Default address 247.

#### Network Distance

4000 feet without network repeater.

#### Nodes

Supports up to 32 modules without the use of a network repeater.

#### Parity

Odd, even, or none. Default setting none.

#### Stop Bits

One with parity, one or two with no parity. Default setting is two stop bits with no parity.

#### Watchdog Timer (Hardware)

A hardware watchdog timer is built into each module to perform a reset if the microcontroller fails to return from an operation in a timely manner or "locks up."

#### Watchdog Timer (Network Communication)

All modules have a communication watchdog timer function. The watchdog timer is configurable for timeout periods of up to 18 hours. This timer function monitors I/O communications with the host controller. In the event of lost communications, output ports optionally reset to a user-defined state or level. The watchdog timer restarts with a read/write to an I/O channel.

### Environmental

#### Ambient Temperature

Operation:

-25°C to +70°C (-13°F to +158°F).

Storage:

-40°C to +85°C (-40°F to +185°F).

#### Relative Humidity

5 to 95% non-condensing.

#### Radiated Field Interference Immunity (RFI)

Complies with EN61000-4-3 Level 2 and EN50082-1 (3V/M, 80 to 1000MHz AM and 900MHz keyed).

#### Electrical Fast Transient Immunity (EFT)

EN61000-4-4 Level 1 and EN50082-1 (0.5KV power, signal lines).

#### Electrostatic Discharge (ESD) Immunity

EN61000-4-2 Level 3 and EN50082-1 (8KV/4KV air/direct discharge).

#### Surge Immunity

EN61000-4-5 (0.5KV) and EN50082-1.

#### Radiated Emissions

Meets EN50081-1 for Class B equipment.

#### Approvals

CE marked. UL listed for US and Canada. Class I; Division 2; Groups A, B, C, D.

### Enclosure/Physical

#### Enclosure

Self-extinguishing NYLON type 6.6 polyamide thermoplastic UL94 V-2, color beige; general purpose NEMA Type 1 enclosure.

#### Connectors (Removable Terminal Blocks)

Wire Range: AWG #12-24, stranded or solid copper.

#### Dimensions

1.05W x 4.68H x 4.35D inches  
26.7W x 118.9H x 110.5D mm.

#### DIN Rail Mounting

DIN rail mount, Type EN50022; "T" rail (35mm).

#### Shipping Weight

1 pound (0.45 Kg) packed.

## Ordering Information

Description	Order Number
4-channel current output module	DI-917MB
4-channel voltage output module	DI-918MB
DI-900MB Configuration Kit (includes Configuration Software, RS-232/485 non-isolated converter, and RS-485 to 3-wire cable, 8ft.)	100969
RS-232 to USB Adaptor	100970
19" rack mount kit with DIN rail	100971
RS-232 cable for 100974 and 100957 products (DB-9 to three-wire)	100976
Isolated Network Repeater, 115 VAC Power	100977
Isolated Network Repeater, 230 VAC Power	100978
115V AC Power Cord for 100977 and 100978 products	100979
50W universal power supply; 24V DC @ 2.1A (50W) output; 85-264V AC or 105-370V DC input	100980

### Data Acquisition Product Links

(click on text to jump to page)

[Data Acquisition](#) | [Data Logger](#) | [Chart Recorder](#) | [Thermocouple](#) | [Oscilloscope](#)