

**1000 VDC and Peak AC
Input-to-Output and
Channel-to-Channel
Isolation**

Supports Seven TC Types

**Built-In Open TC
Detection**

**High Accuracy and
Resolution Design**

**Extremely Wide CJC
Range**

Built-in RS-422 Interface

**Optional USB and RS-232
Adapters**

DATAQ Instruments' DI-1000TC Series products are a line of instrumentation modules designed for temperature measurements using thermocouples. The unit is provided in 4- or 8-channel versions, and each channel may be configured in software to support one of seven thermocouple types: J, K, T, E, S, B, or R. Temperature measurements may range from -200°C to $+1820^{\circ}\text{C}$ (-328°F to $+3308^{\circ}\text{F}$), depending upon thermocouple type. Each DI-1000TC thermocouple channel features a panel-mounted, miniature spade connector, and all input channels are electrically isolated from ground and each other up to 1000VDC or peak AC.

Model DI-1000TC is designed for use across the entire spectrum of temperature measurement applications. Its small size and wide measurement range make it a perfect temperature measurement device for laboratory applications. Its isolation feature allows it to be used in more demanding industrial applications that experience the large common mode voltages (off-ground measurements) that are typical of grounded thermocouples. Such measurement situations will prevent non-isolated instruments from making a measurement at best, or destroy them in the worst case.

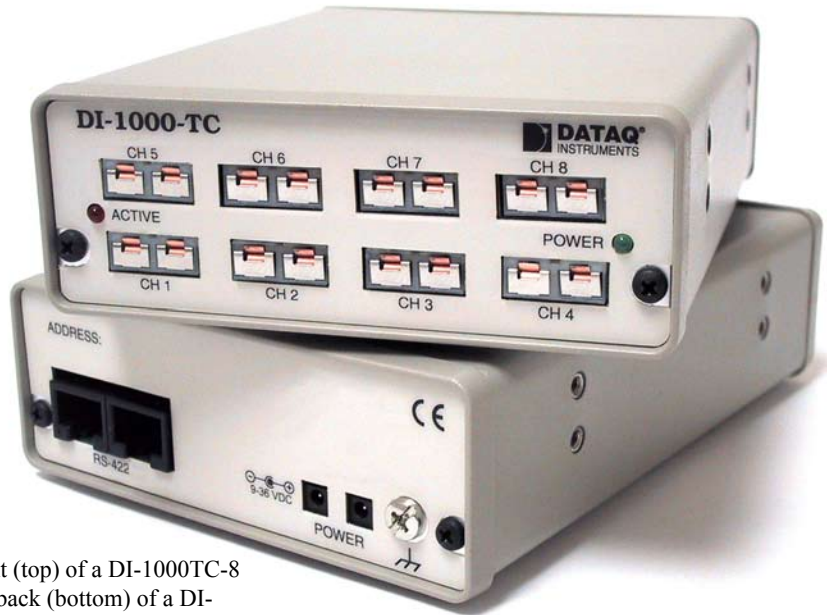

Front (top) of a DI-1000TC-8 and back (bottom) of a DI-1000 Series Instrument.

Features

Expandable

Multiple DI-1000TC units may be connected individually or used as expansion units with any combination of other DI-1000 instruments to address any application-specific situation. For example, multiple DI-1000TCs may be connected to each other to provide unique twelve, sixteen, twenty, or other channel counts. DI-1000TC products may also be mixed and matched with other DI-1000 instruments to yield unique measurement configurations that feature various input types (e.g. simultaneous TC, strain, digital I/O, and voltage) all with sample synchronization.

Built-in RS-422 Interface

The built-in RS-422 interface allows DI-1000TC units to connect to any host PC through an inexpensive adapter via an RS-232 or USB port. This RS-422 interface also serves as an expansion port for other DI-1000 Series instruments.

Isolation

The DI-1000TC's 1000VDC and Peak AC input-to-output and channel-to-channel isolation allows grounded TC measurements.

High Accuracy and Resolution Design

Allows sharpened decisions with an overall accuracy of $\pm 0.2\%$ of span, and temperature resolution as fine as 0.08°C .

Portable

Like all DI-1000 Series instruments, the DI-1000TC is provided in a small (13.81D x 10.48W x 3.81H centimeters; 5-7/16D x 4-1/8W x 1-1/2H inches) enclosure consisting of an aluminum base and all-steel wraparound.

Primary Customers

Those who need a PC-based temperature measurement instrument for laboratory or classroom use. Examples include physics, chemistry, biology, and any other discipline that requires accurate and ready-to-run temperature measurements. Those who require a rugged and flexible device for temperature measurements in industrial settings where off-ground measurements are common. Specific applications are temperature measurements in:

- Steel and aluminum smelting operations
- Annealing operations
- Hydraulic pumps, fluids, and motors
- Steam, gas, and hydraulic turbines
- Machine tools
- Motors and generators
- Rolling mill machinery and equipment
- Electric and gas welding and soldering equipment
- Industrial and commercial fans and blowers and air purification
- Industrial process furnaces and ovens
- Induction heaters
- And many, many more

Specifications

Number of Channels: Configurable as 4 or 8 channel modules within one enclosure

Supported Thermocouple Types: J, K, T, E, S, B, R - mix and match as required

Thermocouple Input Connectors: Panel-mounted miniature spade, universal TC-type

Temperature Range and Accuracy: See table below.

Open TC detection: An open thermocouple forces the channel to minus full scale.

Cold Junction Sensors: One for every group of 4 or 8 channels, depending upon configuration

Cold Junction Compensation Range: -40 to 125°C

Linearization: Accomplished transparently by the software driver to deliver scale temperature values to the host program.

Input Impedance: >1MΩ

Input Current: <0.05μA

Input Offset Voltage: <5μV

Maximum Normal Mode Voltage: 250VDC/Peak AC momentary; 50VDC/Peak AC continuous

Maximum Common Mode Voltage: 1000VDC or Peak AC

Common Mode Rejection: >160db @ 50 and 60Hz

Channel-to-Channel Isolation: 1000VDC or Peak AC

Input-to-Output Isolation: 1000VDC or Peak AC

Channel-to-Channel Cross Talk Rejection: >160db

Temperature Coefficient: <0.040μV/°C

Digital Filtering: 256-tap comb filter per channel, decimating

Voltage Range: -10mV to 50mV

Expansion Capabilities

Method: Via integral RS-422 port to other DI-1000 Series modules

Max. Sample Rate from Expansion

Units: 5 samples/second/channel

Maximum Distance: 4,000 feet

Scanning Characteristics

Maximum Sample Rate: 5 samples/second/channel

Minimum Sample Rate: 0.55 samples/hour/channel

Scan List: 9-position, 8 positions may be programmed for channel number and TC type; ninth position reserved for CJC access

Synchronization: Digital via expansion port to synchronize multiple modules

Sample Buffer: 36 samples

Calibration

Calibration Cycle: One year

Calibration Method: Calibration constants are stored within each module's EEPROM. Provided calibration software to automate calibration in the field.

RS-422 Interface

Supported Baud Rates: 9600 (default), 19200, 38400, 56800, 115200

Data Bits: 8

Stop Bits: 1

Parity: None

Handshaking: ModBus protocol

Connector: RJ-45

General

Panel Indicators: Power and Active LEDs

Operating Environment: -40 to +85°C

Enclosure: Aluminum base with steel wrap-around. Aluminum end-panels with plastic bezels.

Dimensions: 5-7/16D x 4-1/8W x 1-1/2H inches 13.81D x 10.48W x 3.81H centimeters

Weight: 20 oz. (8-channel version)

Power Requirements: 9 to 36 VDC, 1 watt

DI-1000TC Block Diagram

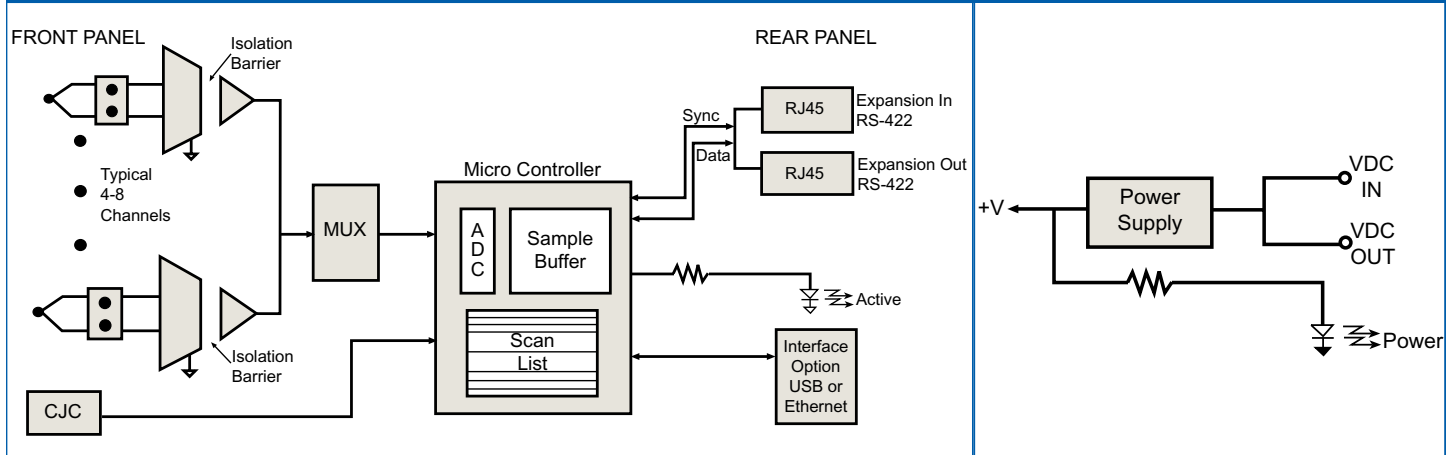

Temperature Range and Accuracy

TC Type	Range	Accuracy*	Resolution**
J	-200 to 870°C	±0.3%	0.1°C
K	-200 to 1230°C	±0.2%	0.1°C
T	-200 to 400°C	±0.5%	0.08°C
E	-200 to 660°C	±0.3%	0.2°C
S	-200 to 1760°C	±0.4%	0.4°C
B	-200 to 1820°C	±0.6%	0.5°C
R	-200 to 1760°C	±0.4%	0.4°C

*25°C ambient temperature; excludes CJC errors; excludes TC errors. Value shown is a percent of full-scale range.
 **Resolution is for temperatures above 0°C.

Ordering Guide

Description	Order No.
4-channel DI-1000TC 4-channel DI-1000TC with RS-422 interface, for temperature measurement using thermocouples.	DI-1000TC-4
8-channel DI-1000TC 8-channel DI-1000TC with RS-422 interface, for temperature measurement using thermocouples.	DI-1000TC-8
USB to RS-422 adapter	DI-1000-USB
RS-232 to RS-422 adapter	DI-1000-232



241 Springside Drive
 Akron, Ohio 44333
 Phone: 330-668-1444 Fax: 330-666-5434
 www.dataq.com

Cost-Effectively Signal Condition, Digitize, and Interface Industrial Measurements to any PC

Completely Portable, Interchangeable, and Expandable

RS-422 Interface with Optional USB and RS-232 Adapters

Compact and Stackable

Transparent Data Acquisition Synchronization

Built-In Channel-to-Channel and Input-to-Output Isolation

DI-1000 instruments are designed from the ground up to cost-effectively signal condition, digitize, and interface industrial measurements to personal computers. They employ a revolutionary design that makes crucial and typically costly input-to-output and channel-to-channel isolation as inexpensive as solutions that offer no isolation at all. A built-in digitizer offers convenience and simplifies wiring and overall implementation.

All DI-1000 products feature a built-in RS-422 interface. This interface is used to communicate among multiple modules, thereby providing a convenient approach to module expansion that can span distances as great as 4,000 feet (over 1,200 meters). Any single module, or the first in an array of expanded modules, can communicate data for itself and/or the other modules directly with the host PC over the PC's RS-232 or USB port using an inexpensive adapter.

The DI-1000's integrated signal conditioning, A/D conversion, and connectivity features combine to provide a solution that affordably supports local, remote, or distributed data acquisition for a variety of input types and situations.



Front (top) of a DI-1000TC-8 and back (bottom) of a DI-1000 Series Instrument.

Features

Portable

Each instrument in the DI-1000 line is offered in a small, all-metal enclosure that measures only 5-7/16"D × 4-1/8"W × 1-1/2"H inches (13.81D × 10.48W × 3.81 centimeters). Many configurations even allow the instrument to be powered directly by the host PC.

Adaptable

DI-1000 instruments can connect to virtually any industrial signal, including voltage, strain, thermocouple, and discrete I/O. More will be added in the future. Each instrument may be ordered in a variety of channel configurations ranging from as few as two to as many as eight channels. You pay only for what you need. Also, each DI-1000 channel offers input-to-output isolation so you can connect them in any measurement situation with complete safety and confidence.

Interchangeable

You can mix and match DI-1000 instruments to adapt to any application. Use voltage modules with any combination of strain, discrete, and thermocouple modules to perfectly dovetail the instrument with the measurement.

Synchronizable

Channel measurements from one DI-1000 unit, or many units spread out as far as 4,000 feet, are fully synchronized. Measurement synchronization allows meaningful cause and effect evaluations to be made, and conclusions drawn from a wide range of process monitoring and troubleshooting situations.

Stackable

Since the various models of DI-1000 Series products share the same enclosure design, they can easily be stacked in the work area to simplify wiring and eliminate clutter.

Expandable

As your needs expand, new modules can be added to existing modules to enhance channel count, measurement function, or both. Buy only what you need today with complete confidence that you can add incrementally and synchronize any channel count and measurement function any time in the future. Connect multiple DI-1000 instruments to each other and to the USB or RS-232 adapter using Standard Category 5 (CAT5) Cables.

Affordable

DI-1000 Series instruments incorporate a revolutionary design approach that yields a price/performance breakthrough for isolated instrumentation. These designs provide isolated signal conditioning, A/D conversion, and a computer interface for a price per channel that is lower than the signal conditioner prices alone of competing products. No other product line offers so much instrumentation capability for so little cost.

Connectable

The built-in RS-422 interface allows DI-1000 units to connect to any host PC through an inexpensive adapter via an RS-232 or USB port. This RS-422 interface also serves as an expansion port for other DI-1000 Series instruments.

Single Unit Communications Connection

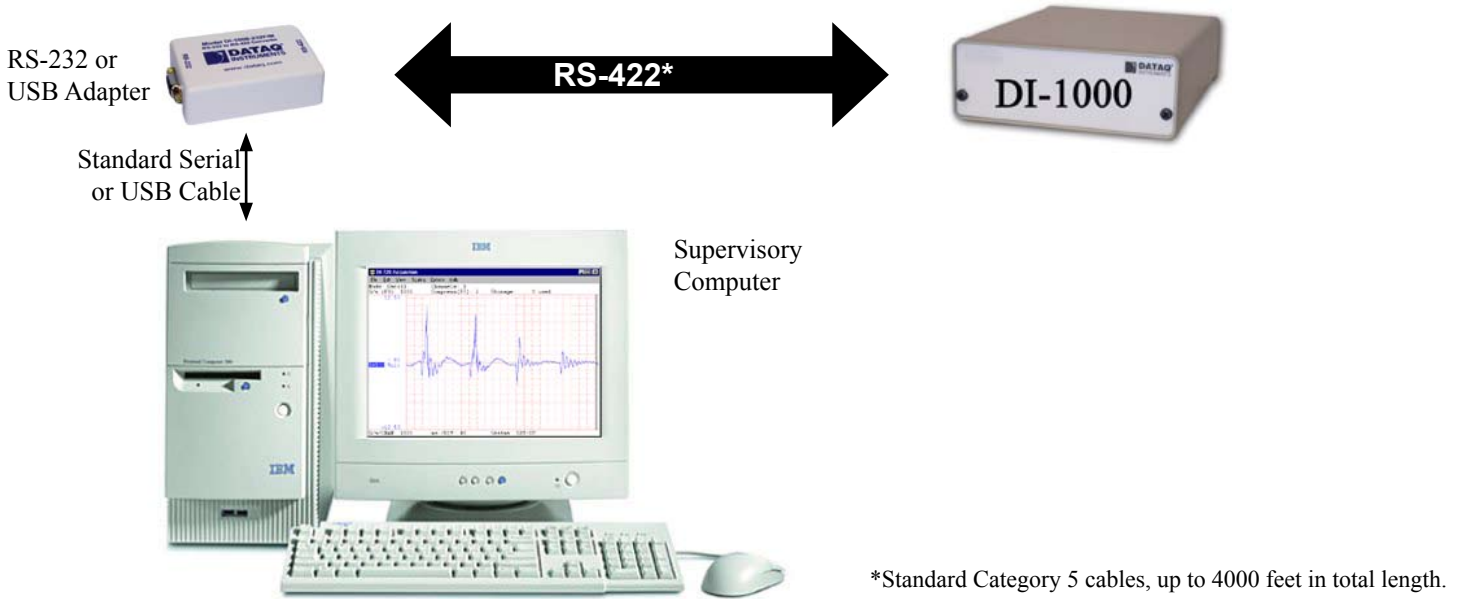

Multi-Unit Communications Connection

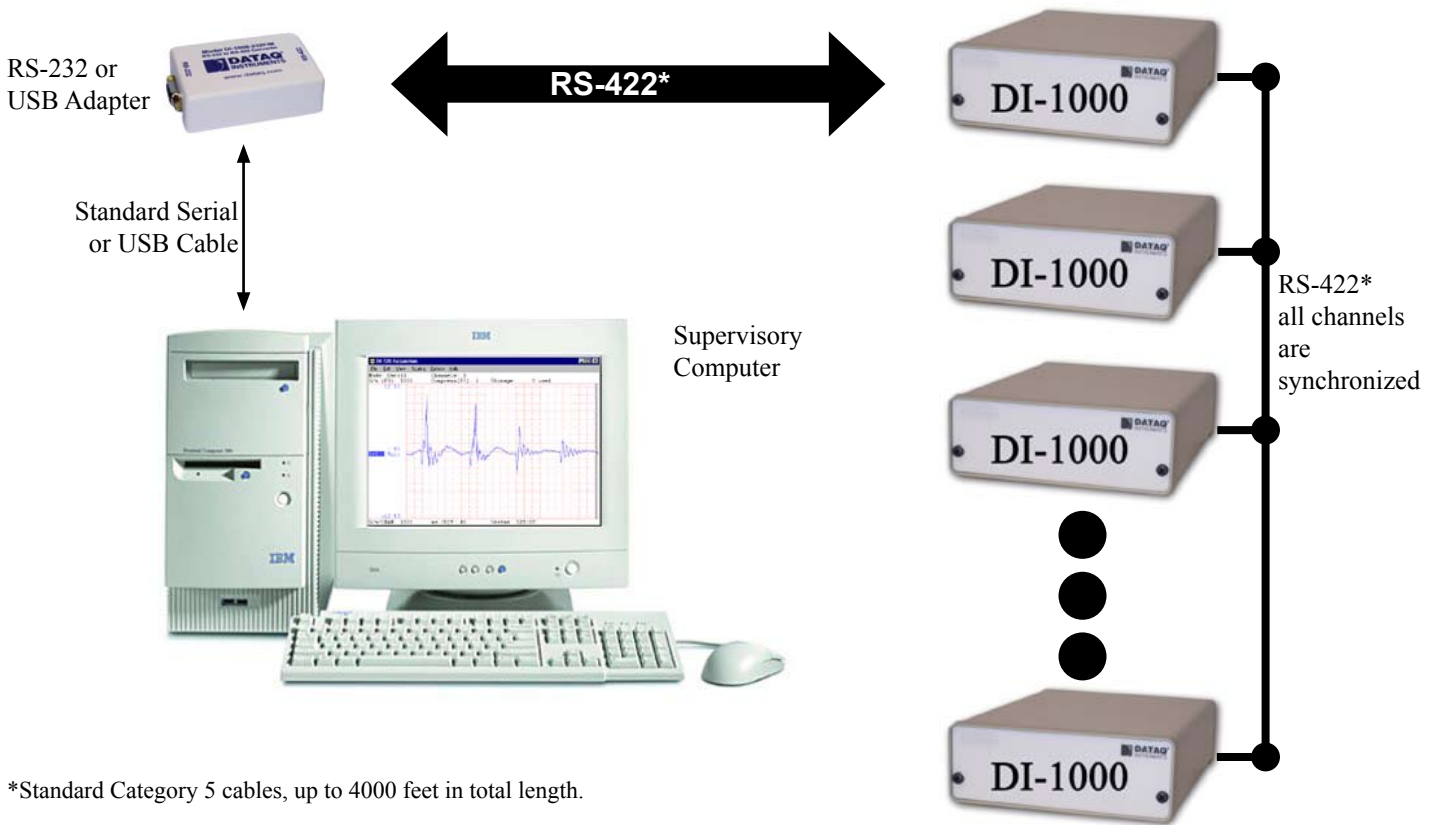

DI-1000 Rear Panel

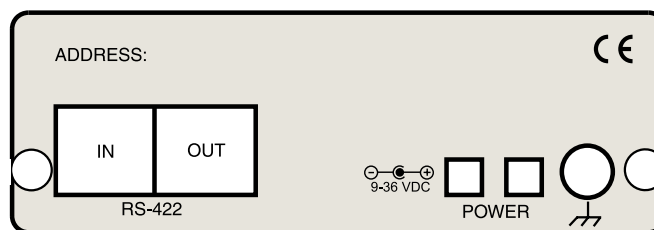

DI-1000 Series Software Environment

Programming Solutions:

LabVIEW

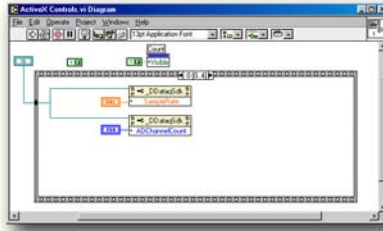

Visual Basic

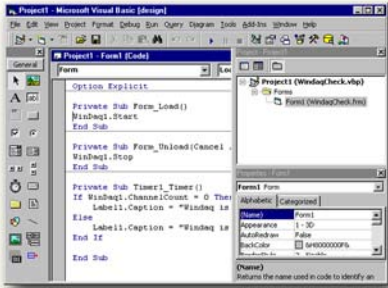

Visual C

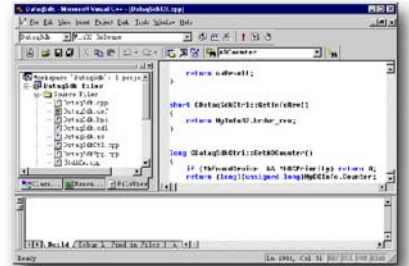

DI-1000 Series
ActiveX Control
Library

XControls Graphic
Instrumentation
Components

Delphi

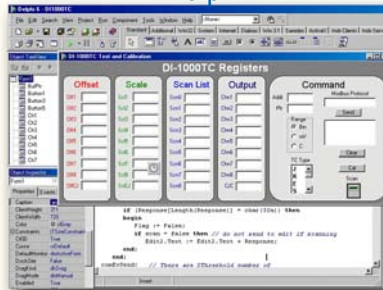

XControls Graphic
Instrumentation
Components

Ready-to-Run Solutions:

DI-1000 Series
ActiveX
Library

WINDAQ Ready-to-Run Software

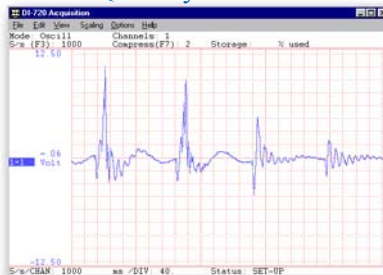

WINDAQ/XL



Software Ordering Guide

Description	Order No.	Description	Order No.
WINDAQ/Lite Recording and Playback software with limited 240Hz record-to-disk rate.	FREE	XControls Instrument Pack 27 ActiveX Controls that are commonly used to provide a realistic virtual instrument environment.	XCTRL-IP-1
WINDAQ/Pro Recording and Playback software limited in that you can only sample multiple channels at one rate.	WINDAQ	Instrument Pack Additional License	XCTRL-IP-2
WINDAQ/Pro Recording and Playback software allowing you to sample different channels at different rates.	WINDAQ/Pro+	Instrument Pack Software Developer's License	XCTRL-IP-3
WINDAQ/XL WINDAQ add-on that allows acquired data to be ported directly to Microsoft Excel.	WINDAQ/XL	XControls Professional Pack Adds 26 controls to the Instrument including tank and valve icons, sliding scale gauges, timers, and more.	XCTRL-PP-1
ActiveX Control Library Programming solution for WINDAQ or any Windows programming language.	FREE	Professional Pack Additional License	XCTRL-PP-2
		Professional Pack Software Developer's License	XCTRL-PP-3



241 Springside Drive
Akron, Ohio 44333
Phone: 330-668-1444 Fax: 330-666-5434
www.dataq.com

Data Acquisition Product Links

(click on text to jump to page)

[Data Acquisition](#)

[Data Logger](#)

[Chart Recorder](#)

[Thermocouple](#)

[Oscilloscope](#)