

DI-942MB

Frequency/Pulse Counter Modules

Periodic or Pulse Waveform Input

Limit Alarms or Discrete Outputs



Models

DI-942MB: 2 input channels

Input

Two input channels:

0 to 50KHz in three selectable ranges

Amplitudes up to 140V AC or 200V peak

Pulse counter range of 0 to 65535

Output

Two output channels:

Solid-state relays (1A DC loads)

0 to 48V DC

Network Communication

Modbus-RTU high-speed RS-485

Power Requirement

10 to 36V DC, 24V AC

Approvals

CE marked. UL, cUL listed

Class I; Division 2; Groups A, B, C, D.

This signal conditioner is a two-channel analog input module with discrete outputs and Modbus communication. It conditions periodic or pulse waveform inputs and provides solid-state relays for limit alarms or ON/OFF control.

Versatile inputs accommodate many applications using TTL, magnetic pickups, proximity sensors, or a variety of switches (high/low-side transistor, dry contact, open drain, open collector). Bipolar and unipolar waveforms are supported with a selectable input bias that accepts both zero and non-zero crossing signals. Voltage threshold and relative hysteresis are also user selectable.

Inputs may also function as event counters with separate microcontrollers for each channel. The module counts pulses on the positive or negative edge. It can wrap around to zero for continuous counting, latch at a programmed count value (setpoint), or automatically reset itself to zero after reaching a setpoint value. Software controls enable remote resets. A variety of filters help remove noise, jitter, and other mechanical effects to prevent false counts.

The discrete outputs can operate as independent alarms or provide on/off control regulated by the host system. As limit alarms, each output can be set for high and/or low setpoints exclusively tied to an analog input. These low cost modules are ideal for standalone alarms as well as for local backup of the primary control system.

Features

- Standard Modbus RTU protocol with high-speed RS-485 communication (up to 115K bps).
- Separate microcontrollers on each channel for pulse counting and period measurement.
- Solid-state relay outputs enable local limit alarms or host-controlled on/off switching.
- Bipolar and unipolar input signal support.
- Programmable pulse counter functions.
- Input filtering functions include hysteresis, averaging, debounce, relay time delay, and alarm deadband controls.
- 4-way isolation (input, output, power, network).
- Watchdog timers provide a failsafe output.
- Self-diagnostics monitor microcontroller activity to detect operational failures (lock-up) and execute a reset to restore communication.

Frequency/Counter Module

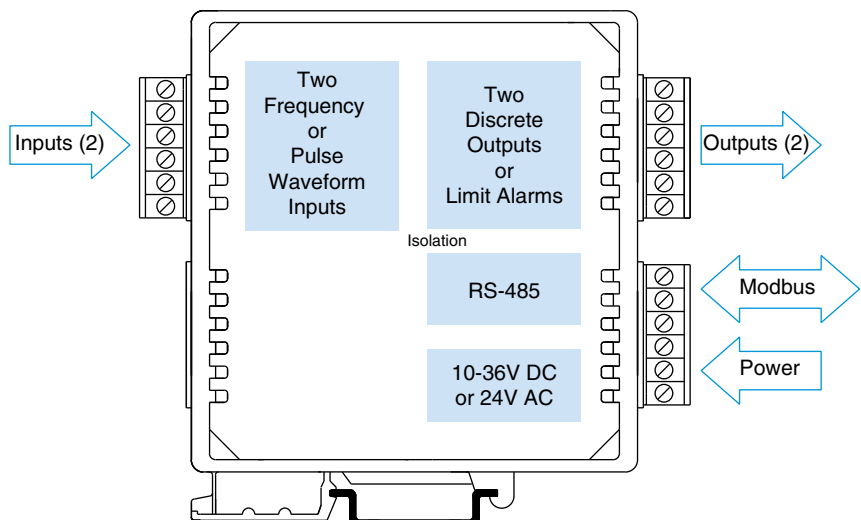

Performance

Frequency/Counter Input

Input Ranges

Input type user-configured. Applies to both channels.

Input Range	Accuracy	Accuracy over Temp.
0 to 100Hz	±0.04Hz	±0.06Hz
0 to 1000Hz	±0.4Hz	±0.6Hz
0 to 50,000Hz	±10Hz	±15Hz
0 to 65,535 pulses	±1 pulse	±1 pulse

Unipolar Input Configuration

Amplitude: 0 to 3V minimum range, 0 to 200V peak maximum range.
 Threshold: Configurable for 1.5V or 5V, typical.
 Hysteresis: Configurable for ±25mV (at 1.5V threshold), or ±83mV (at 5.0V threshold), typical.

Bipolar (Zero-Crossing) Input Configuration

Amplitude (0-20KHz): ±50mV minimum (with ±25mV hysteresis), or ±150mV minimum (with ±83mV hysteresis), to ±200V peak maximum.
 Amplitude (Above 20KHz): ±100mV minimum (with ±25mV hysteresis), or ±200mV minimum (with ±83mV hysteresis), to ±200V peak maximum.
 Threshold: 0mV nominal, 0.01V typical with ±25mV hysteresis; 0.03V typical with ±83mV hysteresis.
 Hysteresis: Configurable for ±25mV or ±83mV, typical.

Resolution

0 to 100Hz input range: 0.01Hz
 0 to 1000Hz input range: 0.1Hz
 0 to 50,000Hz input range: 1Hz
 Pulse counter: 1 pulse

Minimum Input Pulse Width

10µS (frequency input); 5mS (pulse input).

Counting Rate

100Hz maximum counting rate (5mS ON and 5mS OFF for 10mS period or 100Hz).

Input Impedance

35K ohms, typical.

Input Filter Bandwidth

-3dB at 35kHz, typical.

Input Pullup/Pulldown

Software selectable 2.7K ohm input pullup to +5V and a 1K ohm input pulldown to return. The resistors may also be left floating (none).

Input Debounce

0 to 1.375 seconds, configurable in 5mS increments.

Noise Rejection

Common mode: 80dB @ 60Hz, typical with 100 ohm input unbalance.

Discrete Output

Output Type

Solid-State Relay (SSR), one Form A (SPST-NO) switch per input channel. Outputs share a common return connection at the RTN terminals for low-side switching.

Output Voltage Range

0 to 48V DC, 1A DC.

Output ON Resistance

0.4 ohms maximum.

Output Response Time

4.1ms typical, from receipt of command to gate transition of the output MOSFET.

Operation

Digital outputs are set to their OFF state following a software or power-on reset.

Outputs can be set to user-defined states following a watchdog timeout.

Communication

Supported Modbus Commands

The command/response protocol for communicating with this module adheres to the Modbus/RTU standard for the following Modbus Functions.

- Read Holding Registers
- Read Coil
- Read Input Registers
- Reset Slave
- Preset Single Register
- Report Slave ID
- Force Multiple Coils
- Force Single Coil
- Preset Multiple Registers

LED Indicators

LEDs indicate power, status, and discrete level/alarm.

Power and Isolation

Power Requirements

10 to 36V DC. 22 to 26V AC.

Isolation

1500V AC for 60 seconds or 250V AC continuous. 4-way isolation between input, network, power and discrete I/O circuits. Inputs are isolated channel-to-channel for common mode voltage to ±5V DC.

ANALOG INPUT CONNECTIONS

FREQUENCY INPUT

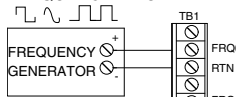

MAGNETIC INPUT

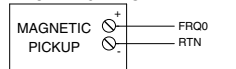

DRY CONTACT

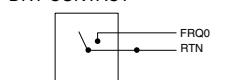

LOW-SIDE SWITCH (Open Collector/Drain)

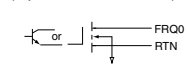

HIGH-SIDE SWITCH (Open Collector/Drain)

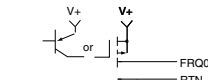

TTL

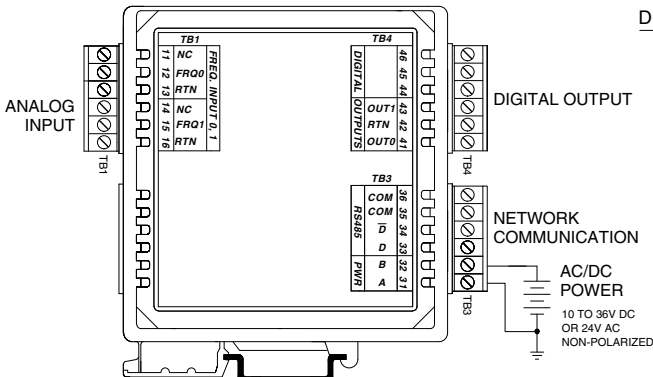
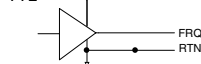

DIGITAL OUTPUT CONNECTIONS

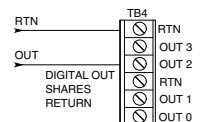
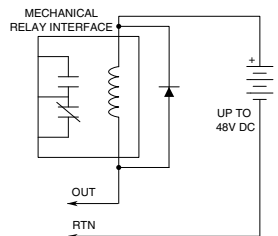

900MB Technical Diagram

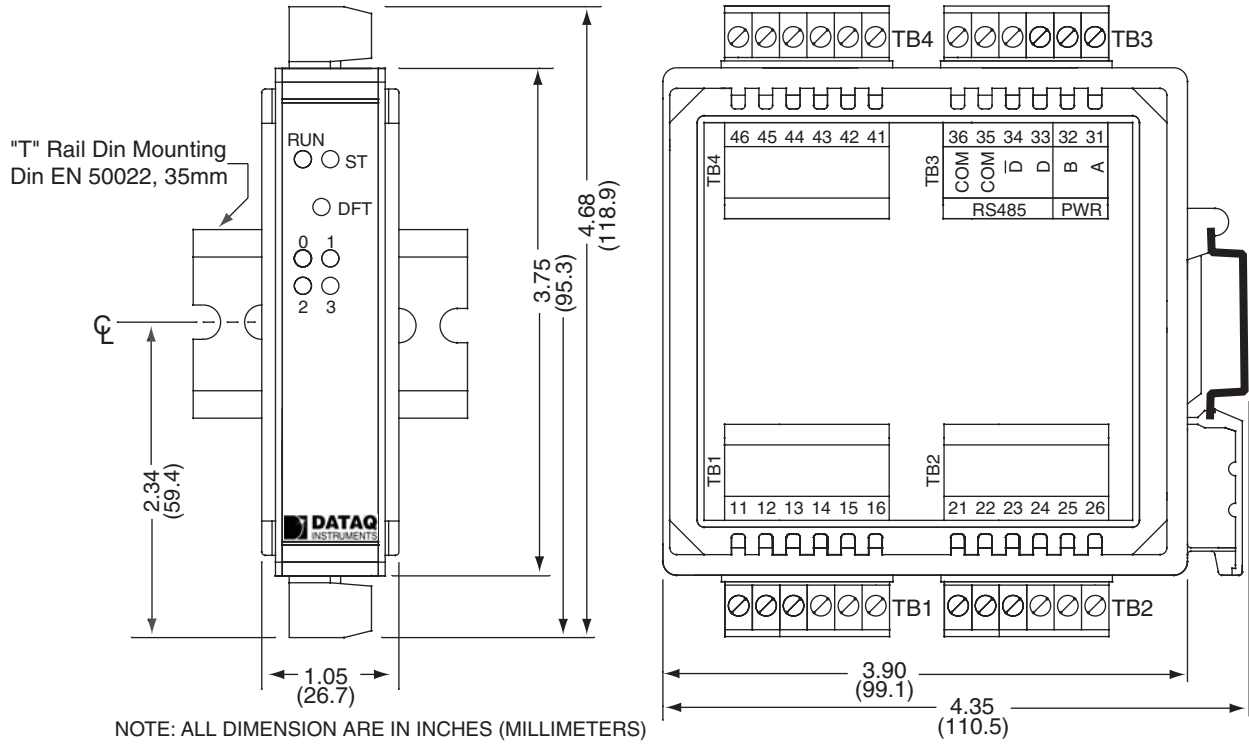

Communication Connections

Personal Computer with
Windows 95, 98, ME, NT, 2000, XP

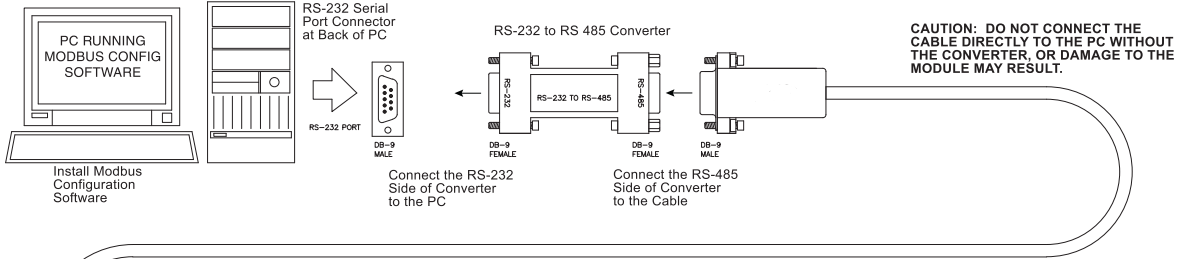

100969 COMMUNICATION CONNECTIONS

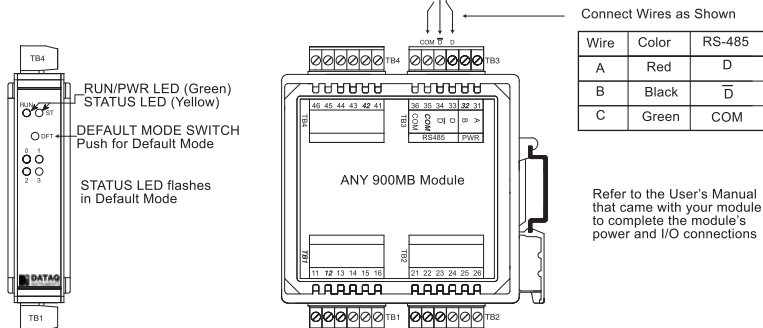

Software Interface Package

DATAQ Instruments, Inc., provides a full set of tools to help you get your modules set up and ready to run in an easy-to-order package that includes the Windows Configuration Software, an RS-232 to RS-485 Serial Port Converter, and an RS-485 Signal Cable.

The Software Interface Package Includes the following:

- Configuration Software for Windows (95, 98, ME, NT, 2000, XP) on CD-ROM.
- Non-isolated RS-232 to RS-485 Serial Port Converter, DB-9S to DB-9F.
- RS-485 to 3-wire Cable Converter, DB-9M to 3 x 12 AWG RS-485 Cable, 8 ft.

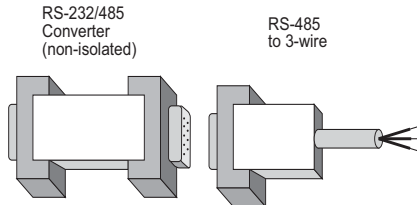
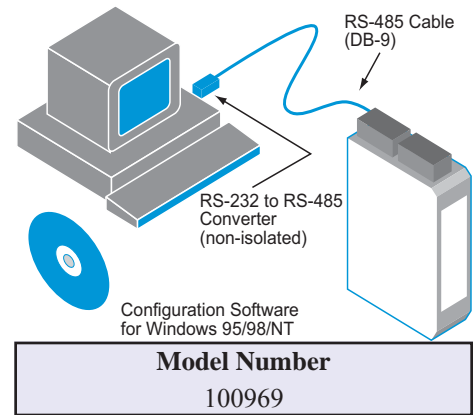

RS-232 to RS-485 Serial Port Converter

This Serial Port Converter is a non-isolated, port-powered, RS232-to-RS485 signal converter. Although the converter receives its power from the RS232 data and handshake lines, no handshaking lines are required to control the converter's RS485 driver. It plugs directly into the DB-9 male RS232 serial port connector on the back of most personal computers via the cable provided in the interface package.

Windows Configuration Software

The Windows Configuration Software provides an easy way to configure your module to whatever your application may be. The configuration software provides the following capabilities:

- Change Host and Slave communication settings (Baud Rate, COM Port, address, et al.
- Monitor the discrete I/O signal states and watchdog status allowing discrete outputs to be turned on/off.
- Allows a configuration to be uploaded or downloaded to/from the module via the RS 485 interface.
- Provides controls to reset the module.
- Reads the contents of the Module Status Register.
- Allows optional user documentation to be saved with a module file.
- Allows a module's complete configuration to be printed in an easy-to-read, single-page format, including user documentation.

Test page (right) simplifies diagnostics with a live visual display of the module's input and output values.

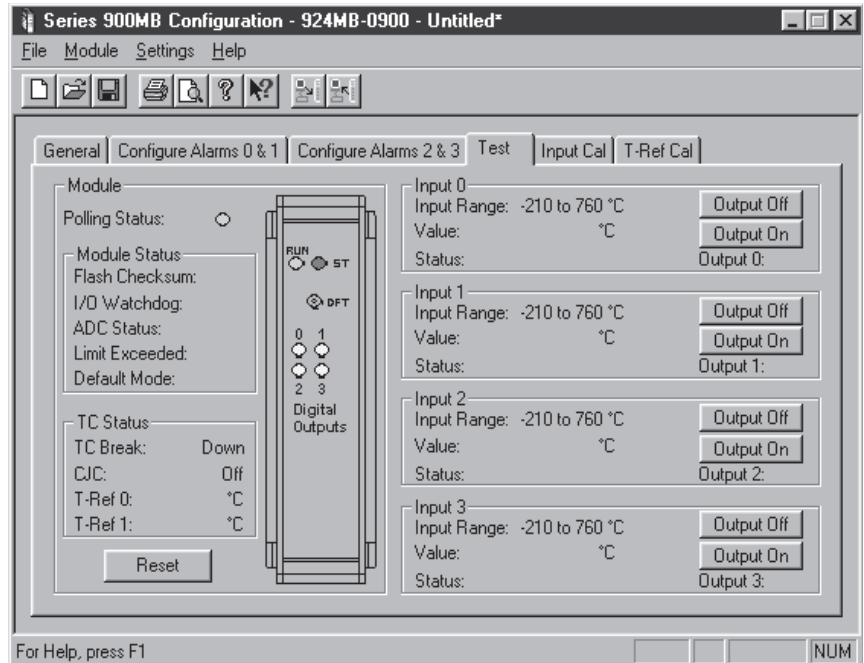

Software Support

DI-900MB series products are designed for Modbus RTU compatibility. Modbus is a communication protocol developed by MODICON, Inc. in 1979. In the years since its release, Modbus has evolved into a truly open standard and has become the most widely used networking communication protocol in the industrial automation field. Virtually all SCADA and HMI application software packages can easily fold DI-900MB devices into any new or existing data acquisition and control environment. DI-900MB products support the RTU (Remote Terminal Unit) Modbus extension, which is a binary protocol providing enhanced performance. The following is a brief list of Human Machine Interface (HMI) software vendors who support the Modbus RTU protocol, and therefore support DI-900MB Series products. The space available does not allow an exhaustive list.

Citect

USA Tel # (704)-329-3838
Web: <http://www.citect.com/>
Modbus-RTU I/O support: DLL Driver - use Modicon PLC 484 Series; OPC Server supplied by others

Intellution/GE Fanuc

USA Tel. (508) 698-3322
Web: <http://www.intellution.com/>
Modbus-RTU I/O support:
OPC Server – supplied by Intellution

Wonderware

USA Tel. 949-727-3200
Web: <http://www.wonderware.com/>
Modbus-RTU I/O support: Driver – Fast DDE; OPC Server – supplied by others

Iconics

USA Tel. (508) 543-8600
Web: <http://www.iconics.com/>
Modbus-RTU I/O support: Driver – supplied by Iconics; OPC Server – supplied by others

OPC Servers Vendors

KEPware, Inc.
USA Tel. 207-864-5881
Web: <http://www.kepware.com/>

Digital Systems, Inc.
USA Tel. 704-895-7713
Web: <http://www.caro.net/dsi/>

Automated Solutions, Inc.
USA Tel. 707-575-9631
Web: <http://www.automatedsolutions.com/>

Isolated Signal Converter

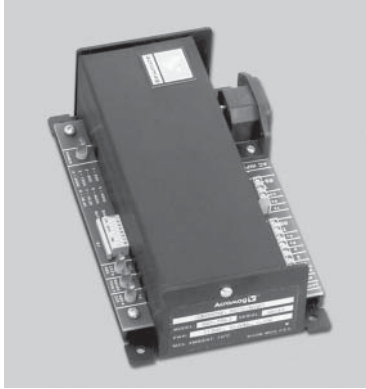

This unit provides an isolated interface between the host PC's RS-232 port and RS-485 Modbus network devices. Signal conversion is bidirectional with operation that is transparent to all devices. The RS-485 network supports up to 32 devices (including the converter) across 4000 foot distances. Installation of additional network devices or extending the distance requires an Isolated Network Repeater (Model Numbers 100977 or 100978). Power cord included. Signal Cable (Model 100976) connects the PC's RS-232 Port to the Isolated Signal Converter.

Specifications

Baud Rates

Switch-selectable from 300 to 38.4K baud.

Duplex

Half duplex only.

Network Termination Resistors

Two terminal blocks and 120 ohm resistors provided to terminate both ends of the RS-485 network.

Wiring Connectors

Terminal blocks with screw clamps for 14-26AWG

Operating Temperature Range

-25 to 60°C (-13 to 140°F)

Isolation

Withstands 1500V AC surge for 60 seconds (250V AC or 354V DC continuous).

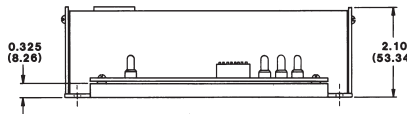
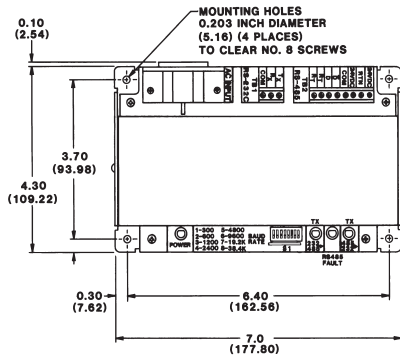

Model Numbers

100974 (115V AC Power) (discontinued)
 100975 (230V AC Power) (discontinued)
 100976 (8ft. long DB-9 to 3-wire RS-232 Cable)

System Connection

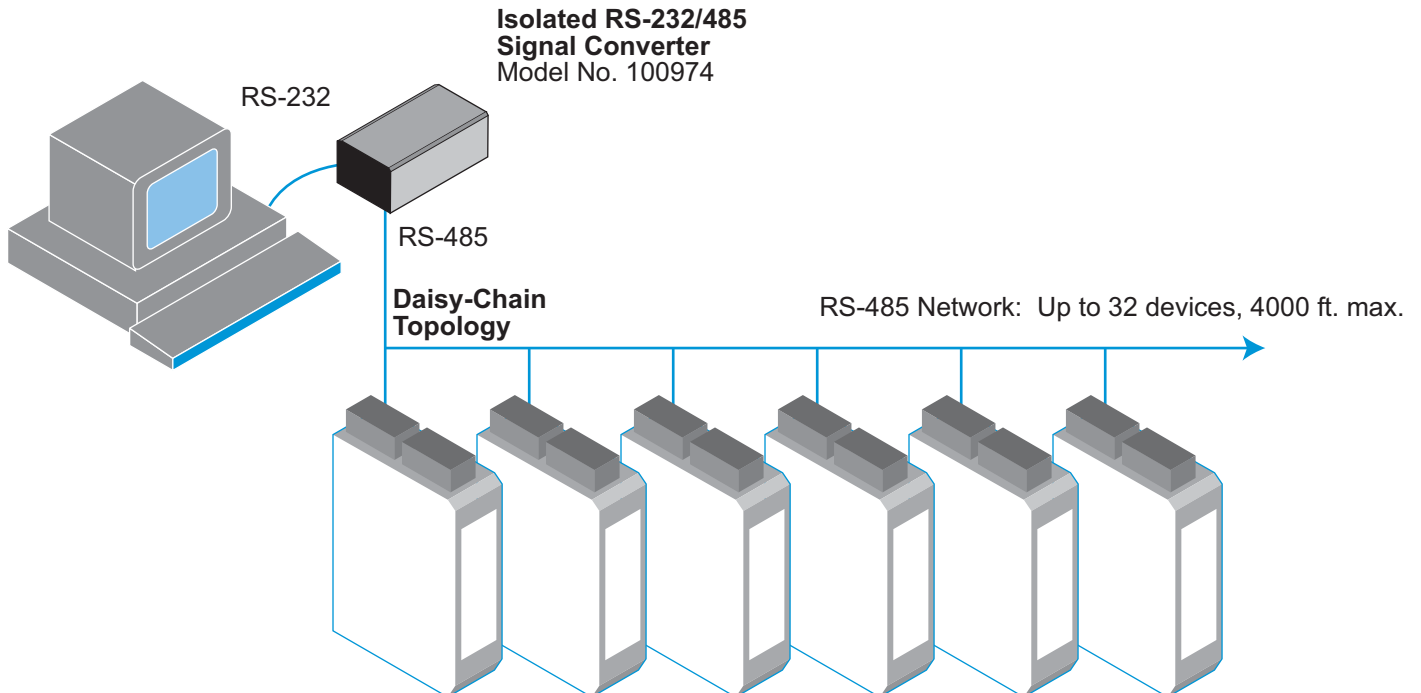

Isolated Network Repeater



This unit isolates and boosts RS-485 signals to extend communication distances or increase the number of devices on the network. Each Repeater permits the addition of a network branch with up to 32 devices (including the Network Repeater) and will transmit RS-485 signals another 4000 feet. Operation is transparent to all devices and no handshaking is required. Two terminal blocks are provided for 120 ohm resistors to terminate both ends of the network branch.

Specifications

Baud Rates

Switch-selectable from 300 to 38.4K baud.

Duplex

Half duplex only.

Network Termination Resistors

Two terminal blocks and 120 ohm resistors provided to terminate both ends of the RS-485 network.

RS-485 Wiring Connectors

Terminal blocks with screw clamps for 14-26AWG.

Power Wiring Connections

Terminal block with screw clamps for 12-18AWG.

Operating Temperature Range

-25 to 60°C (-13 to 140°F).

Isolation

Withstands 1500V AC surge for 60 seconds (250V AC or 354V DC continuous).

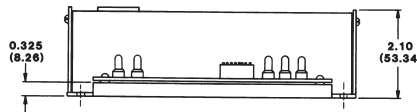
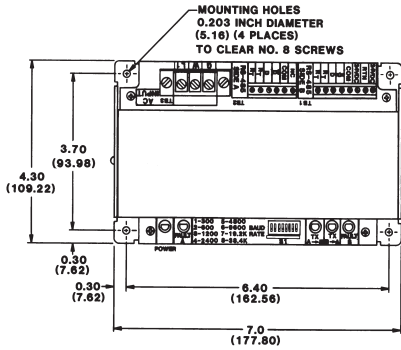

Model Numbers

- 100977 (115V AC Power)
- 100978 (230V AC Power)
- 100979 (115V AC Power Cord)

Extending the Network

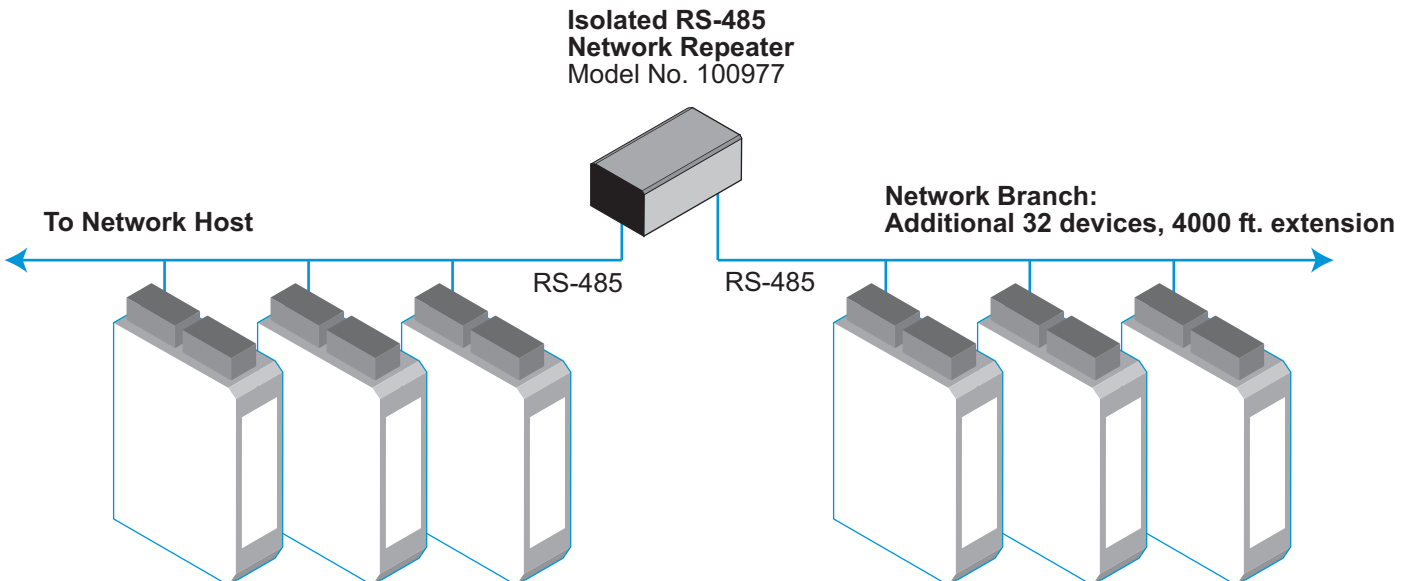

Universal 50W Power Supply

This Universal 50W Power Supply is the ideal power source to drive your network.



Input Power Requirement
 Universal power
 85 to 264V AC,
 105 to 370V DC

Output
 24V DC, 2.1A (50W)

Top View

(dimensions in mm)

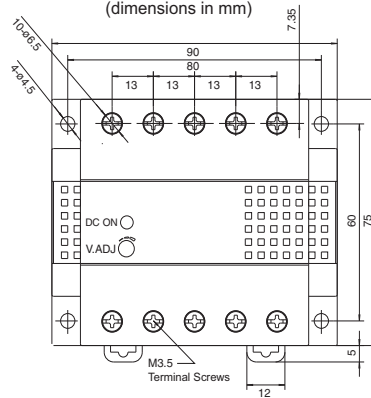

Side View

(dimensions in mm)

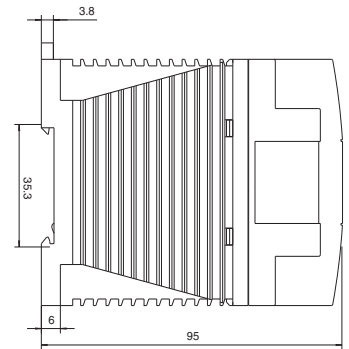

Model Number

100980

DIN-Rail Mounting

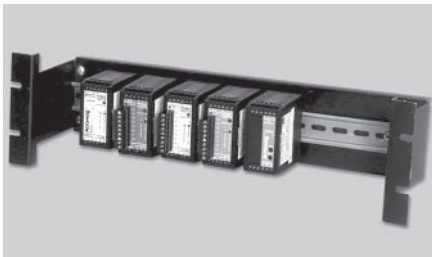

For your convenience, DATAQ Instruments, Inc., offers a rack mount kit to simplify your system installation. This 19-inch kit provides a clean solution for mounting your I/O modules and a power supply. Holds up to 16 DI-900MB modules.

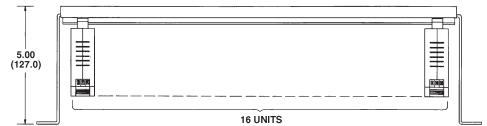
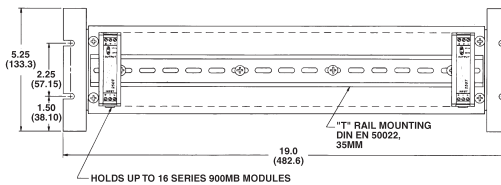

Model Number

100971

USB to RS-232 Adapter



Convert signals from RS-232 to USB with this convenient adapter. For use with all DI-900MB Series modules.

Dimensions

Length: 3.15 in (8.0 cm)
 Height: 0.80 in (2.03 cm)
 Width: 1.75 in (4.44 cm)
 Weight: 1.6 oz (45.36 g)

Model Number

100970

General Module Specifications

Communication Interface

Network Communication

Modbus-RTU protocol, RS485 (3-Wire). Standard Protocol implementation as defined under "Modicon Modbus Reference Guide" PI-MBUS-300 Rev. J. Reference: <http://public.modicon.com>. Search on: PI-MBUS-300 for technical publication.

Baud Rate

2400, 4800, 9600, 14.4k, 19.2k, 28.8k, 38.4k, 57.6k, 76.8k, or 115.2k baud. Default 9600 baud.

Module Addressing

0 to 247, selectable. Default address 247.

Network Distance

4000 feet without network repeater.

Nodes

Supports up to 32 modules without the use of a network repeater.

Parity

Odd, even, or none. Default setting none.

Stop Bits

One with parity, one or two with no parity. Default setting is two stop bits with no parity.

Watchdog Timer (Hardware)

A hardware watchdog timer is built into each module to perform a reset if the microcontroller fails to return from an operation in a timely manner or "locks up."

Watchdog Timer (Network Communication)

All modules have a communication watchdog timer function. The watchdog timer is configurable for timeout periods of up to 18 hours. This timer function monitors I/O communications with the host controller. In the event of lost communications, output ports optionally reset to a user-defined state or level. The watchdog timer restarts with a read/write to an I/O channel.

Environmental

Ambient Temperature

Operation:

-25°C to +70°C (-13°F to +158°F).

Storage:

-40°C to +85°C (-40°F to +185°F).

Relative Humidity

5 to 95% non-condensing.

Radiated Field Interference Immunity (RFI)

Complies with EN61000-4-3 Level 2 and EN50082-1 (3V/M, 80 to 1000MHz AM and 900MHz keyed).

Electrical Fast Transient Immunity (EFT)

EN61000-4-4 Level 1 and EN50082-1 (0.5KV power, signal lines).

Electrostatic Discharge (ESD) Immunity

EN61000-4-2 Level 3 and EN50082-1 (8KV/4KV air/direct discharge).

Surge Immunity

EN61000-4-5 (0.5KV) and EN50082-1.

Radiated Emissions

Meets EN50081-1 for Class B equipment

Approvals

CE marked. UL listed for US and Canada. Class I; Division 2; Groups A, B, C, D.

Enclosure/Physical

Enclosure

Self-extinguishing NYLON type 6.6 polyamide thermoplastic UL94 V-2, color beige; general purpose NEMA Type 1 enclosure.

Connectors (Removable Terminal Blocks)

Wire Range: AWG #12-24, stranded or solid copper.

Dimensions

1.05W x 4.68H x 4.35D inches

26.7W x 118.9H x 110.5D mm.

DIN Rail Mounting

DIN rail mount, Type EN50022; "T" rail (35mm).

Shipping Weight

1 pound (0.45 Kg) packed.

Ordering Information

Description	Order Number
2-channel frequency/counter input module	DI-942MB
DI-900MB Configuration Kit (includes Configuration Software, RS-232/485 non-isolated converter, and RS-485 to 3-wire cable, 8ft.)	100969
RS-232 to USB Adaptor	100970
19" rack mount kit with DIN rail	100971
RS-232 cable for 100974 and 100975 products (DB-9 to three-wire)	100976
Isolated Network Repeater, 115 VAC Power	100977
Isolated Network Repeater, 230 VAC Power	100978
115V AC Power Cord for 100977 and 100978 products	100979
50W universal power supply; 24V DC @ 2.1A (50W) output; 85-264V AC or 105-370V DC input	100980

Data Acquisition Product Links

(click on text to jump to page)

[Data Acquisition](#) | [Data Logger](#) | [Chart Recorder](#) | [Thermocouple](#) | [Oscilloscope](#)